

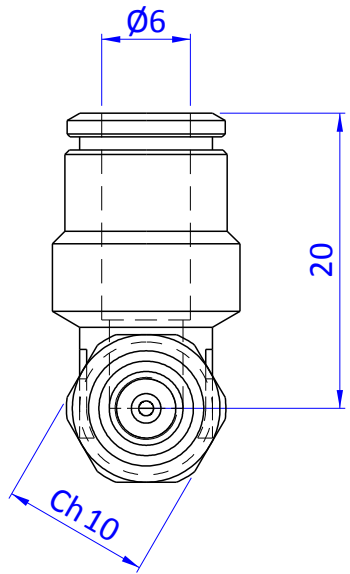

THE PROPERTY OF THE DRAWING IS ESTABLISHED BY LAW. IT IS FORBIDDEN TO PRODUCE OR SHOW IT TO THIRD PART. WITHOUT A WRITTEN AGREEMENT.

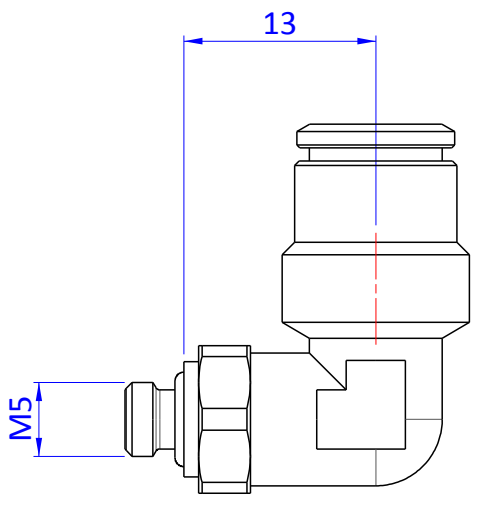
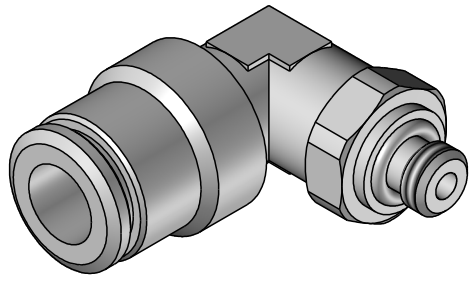
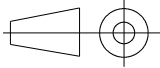

Format A4 UNI 936-76				DESIGNED FROM FPS Automation		REVIEW A
				DATE 07/06/2019	WEIGHT 0.014Kg	
	GENERAL TOLERANCE UNI - ISO 2768 CLASSE f	DESCRIPTION CA.12.05.020		CODE CA.12.05.020		